



**DUKERS**  
Quality Commercial Refrigeration

Item # \_\_\_\_\_

Qty # \_\_\_\_\_

Model # \_\_\_\_\_

Project # \_\_\_\_\_



**STOCK  
POT  
DCSP1**



Catch Tray



Ventilation



Legs











Knobs



Cast Iron  
Cooking Surface



**PRODUCT DESCRIPTION**

-  Stainless steel sides and front valve cover.
-  Stainless steel tubing for pilots and pilot tips per burner ring.
-  Heavy duty cast iron three-ring burner, rated at a total of 80,000 BTU/h.
-  Each burner is equipped with two continuous pilots.
-  Heavy duty cast iron and top grates.
-  Two manual controls to operate the inner and outer rings independently.
-  3/4" NPT rear gas connection and regulator standard.
-  Stainless steel legs standard.
-  Full length seamless drip pan for easy cleanup.



**HIGH QUALITY  
STAINLESS STEEL &  
ROBUST DESIGN**

STOCK POT MODEL	DIMENSION		
	Width	Depth	Height
DCSP1	18 in	27 1/2 in	22 5/8 in



Los Angeles | San Francisco | Dallas  
Houston | Florida | Chicago | New Jersey

1-800-931-8628

@ info@dukersusa.com

www.DukersUSA.com

# DETAILS & SPECIFICATIONS

## STOCK POT DCSP1

Front View

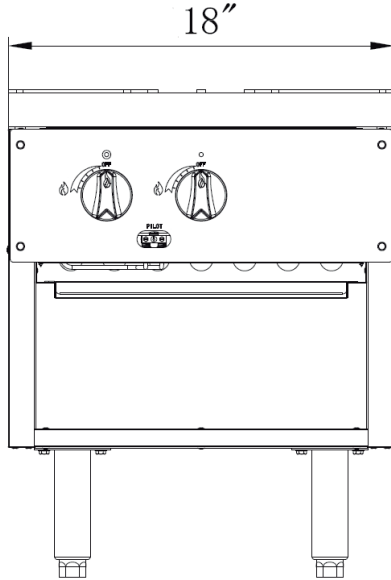

Side View

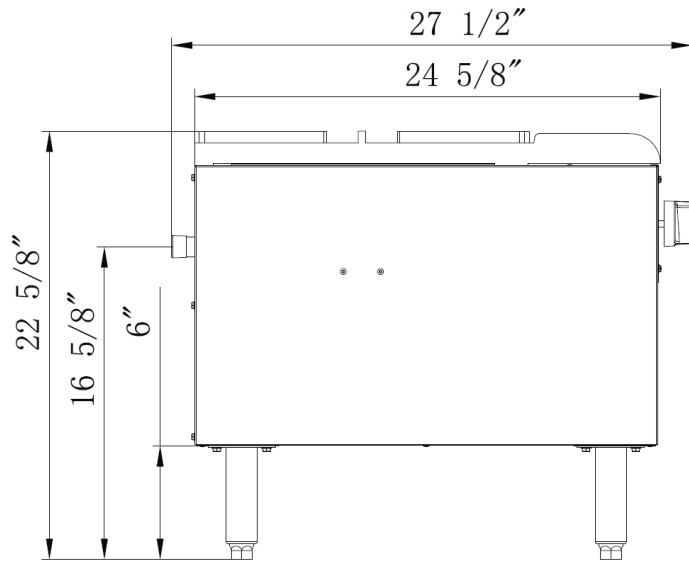

Top View

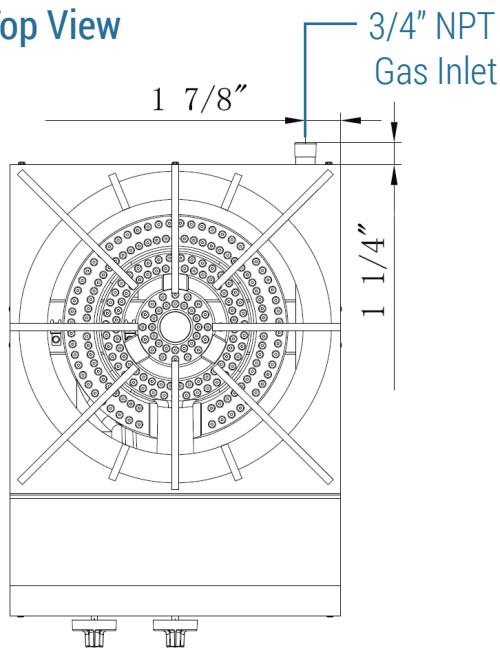

### DCSP1

GAS SOURCE	NG/Propane
COOKING AREA	18x18in
BURNER	2 count
SINGLE BURNER	40000 BTU/H
COMBINED	80000 BTU/H
GAS PRESSURE	NG: 5 "WC Propane: 10 "WC
NOZZEL	NG: 32# Propane: 48#



Model	Packaging Dimensions (inches)			Net Weight (lbs)	Ship Weight (lbs)	Container Capacity 40'HQ
	W	D	H			
DCSP1	21 1/8"	30 7/8"	24"	115	157	240



Los Angeles | San Francisco | Dallas  
Houston | Florida | Chicago | New Jersey

1-800-931-8628

@ info@dukersusa.com

www.DukersUSA.com